

95 Gallon Roll Out Cart

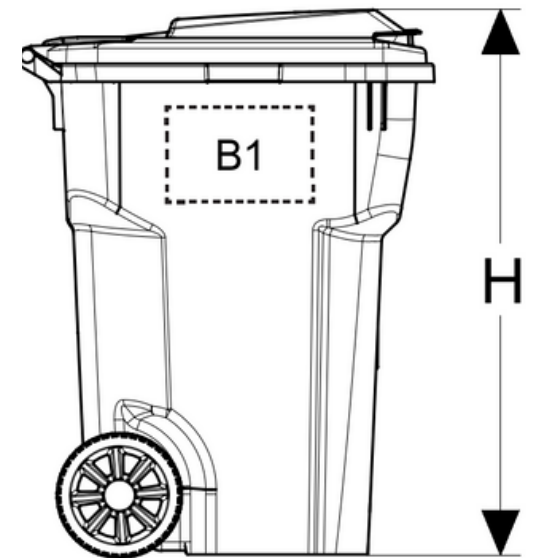
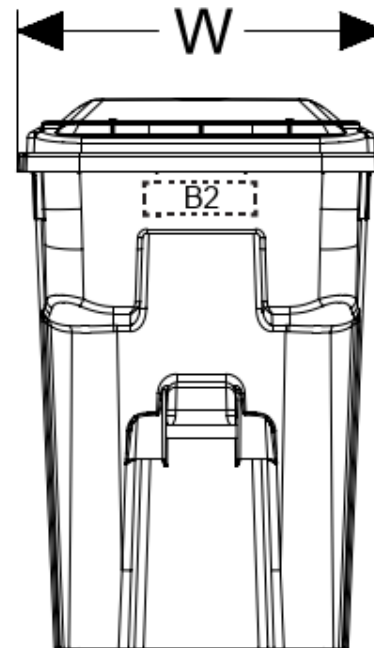
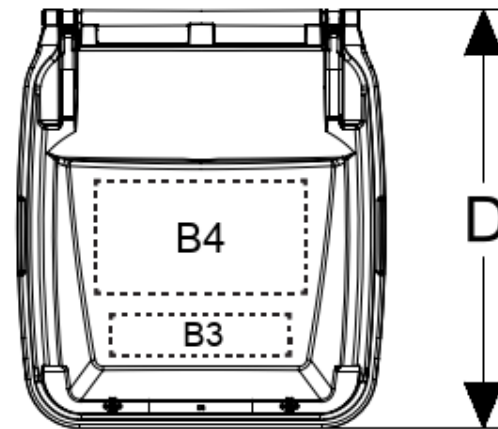

Specifications	IN/LB	CM/KG
Capacity (Gallons / Liters)	95 Gal	360 L
Overall Depth (D)	33.3	84.5
Overall Width (W)	29.2	74.1
Overall Height with Lid (H)	43.5	110.4